

# TSK60R190S1

## 600V 20A N-Channel SJ-MOSFET

### General Description

Truesemi SJ-FET is new generation of high voltage MOSFET family that is utilizing an advanced charge balance mechanism for outstanding low on-resistance and lower gate charge performance.

This advanced technology has been tailored to minimize conduction loss, provide superior switching performance, and withstand extreme dv/dt rate and higher avalanche energy.

SJ-FET is suitable for various AC/DC power conversion in switching mode operation for higher efficiency.

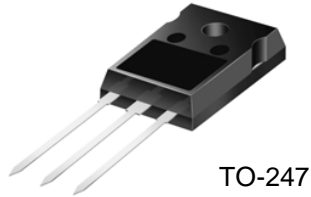

TO-247

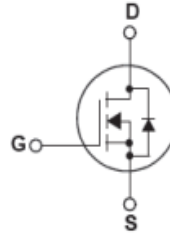

### Features

- 650V @ $T_J = 150\text{ }^\circ\text{C}$
- Typ.  $R_{DS(on)} = 0.16\Omega$
- Ultra Low gate charge (typ.  $Q_g = 70\text{nC}$ )
- 100% avalanche tested

### Absolute Maximum Ratings

Symbol	Parameter	Value	Unit
$V_{DSS}$	Drain-Source Voltage	600	V
$I_D$	Drain Current -Continuous ( $TC = 25^\circ\text{C}$ )	20*	A
	-Continuous ( $TC = 100^\circ\text{C}$ )	12.6*	
$I_{DM}$	Drain Current – Pulsed (Note 1)	62	A
$V_{GSS}$	Gate-Source voltage	$\pm 30$	V
$E_{AS}$	Single Pulsed Avalanche Energy (Note 2)	485	mJ
$I_{AR}$	Avalanche Current (Note 1)	3.5	A
$E_{AR}$	Repetitive Avalanche Energy (Note 1)	1	mJ
dv/dt	Peak Diode Recovery dv/dt (Note 3)	15	V/ns
$P_D$	Power Dissipation ( $TC = 25^\circ\text{C}$ )	151	W
	-Derate above $25^\circ\text{C}$	1.67	W/ $^\circ\text{C}$
$T_J, T_{STG}$	Operating and Storage Temperature Range	-55 to +150	$^\circ\text{C}$
$T_L$	Maximum Lead Temperature for Soldering Purpose, 1/8" from Case for 5 Seconds	300	$^\circ\text{C}$

\* Drain current limited by maximum junction temperature.

### Thermal Characteristics

Symbol	Parameter	Value	Unit
$R_{\theta JC}$	Thermal Resistance, Junction-to-Case	0.83	$^\circ\text{C/W}$
$R_{\theta CS}$	Thermal Resistance, Case-to-Sink Typ.	0.5	$^\circ\text{C/W}$
$R_{\theta JA}$	Thermal Resistance, Junction-to-Ambient	62	$^\circ\text{C/W}$

## Electrical Characteristics TC = 25 °C unless otherwise noted

Symbol	Parameter	Conditions	Min	Typ	Max	Unit
Off Characteristics						
BV <sub>DSS</sub>	Drain-Source Breakdown Voltage	V <sub>GS</sub> = 0V, I <sub>D</sub> = 250μA, T <sub>J</sub> = 25 °C	600	--	--	V
		V <sub>GS</sub> = 0V, I <sub>D</sub> = 250μA, T <sub>J</sub> = 150 °C	--	650	--	V
ΔBV <sub>DSS</sub> / ΔT <sub>J</sub>	Breakdown Voltage Temperature Coefficient	I <sub>D</sub> = 250μA, Referenced to 25 °C	--	0.6	--	V/°C
I <sub>DSS</sub>	Zero Gate Voltage Drain Current	V <sub>DS</sub> = 600V, V <sub>GS</sub> = 0V -T <sub>J</sub> = 150 °C	--	-- 10	1 --	μA μA
I <sub>GSSF</sub>	Gate-Body Leakage Current, Forward	V <sub>GS</sub> = 30V, V <sub>DS</sub> = 0V	--	--	100	nA
I <sub>GSSR</sub>	Gate-Body Leakage Current, Reverse	V <sub>GS</sub> = -30V, V <sub>DS</sub> = 0V	--	--	-100	nA
On Characteristics						
V <sub>GS(th)</sub>	Gate Threshold Voltage	V <sub>DS</sub> = V <sub>GS</sub> , I <sub>D</sub> = 250μA	2.5	--	4.5	V
R <sub>DS(on)</sub>	Static Drain-Source On-Resistance	V <sub>GS</sub> = 10V, I <sub>D</sub> = 10A	--	0.16	0.19	Ω
g <sub>FS</sub>	Forward Trans conductance	V <sub>DS</sub> = 40V, I <sub>D</sub> = 10A (Note 4)	--	16	--	S
Dynamic Characteristics						
C <sub>ISS</sub>	Input Capacitance	V <sub>DS</sub> = 25V, V <sub>GS</sub> = 0V, f = 1.0MHz	--	1440	--	pF
C <sub>OSS</sub>	Output Capacitance		--	370	--	pF
C <sub>RSS</sub>	Reverse Transfer Capacitance		--	11	--	pF
t <sub>d(on)</sub>	Turn-On Delay Time	V <sub>DD</sub> = 400V, I <sub>D</sub> = 10A R <sub>G</sub> = 20Ω (Note 4,5)	--	15	--	ns
t <sub>r</sub>	Turn-On Rise Time		--	11	--	ns
t <sub>d(off)</sub>	Turn-Off Delay Time		--	110	--	ns
t <sub>f</sub>	Turn-Off Fall Time		--	9	--	ns
Q <sub>g</sub>	Total Gate Charge	V <sub>DS</sub> = 480V, I <sub>D</sub> = 10A V <sub>GS</sub> = 10V (Note 4,5)	--	70	90	nC
Q <sub>gs</sub>	Gate-Source Charge		--	7.8	--	nC
Q <sub>gd</sub>	Gate-Drain Charge		--	9	--	nC
Drain-Source Diode Characteristics and Maximum Ratings						
I <sub>S</sub>	Maximum Continuous Drain-Source Diode Forward Current		--	--	20	A
I <sub>SM</sub>	Maximum Pulsed Drain-Source Diode Forward Current		--	--	60	A
V <sub>SD</sub>	Drain-Source Diode Forward Voltage	V <sub>GS</sub> = 0V, I <sub>F</sub> = 10A	--	1	1.5	V
t <sub>rr</sub>	Reverse Recovery Time	V <sub>GS</sub> = 0V, I <sub>F</sub> = 10A di <sub>F</sub> /dt = 100A/μs	--	475	--	ns
Q <sub>rr</sub>	Reverse Recovery Charge		--	5.8	--	μC
I <sub>rrm</sub>	Peak reverse recovery Current		--	35	--	A

## NOTES:

1. Repetitive Rating: Pulse width limited by maximum junction temperature
2. I<sub>AS</sub> = 3.5A, V<sub>DD</sub> = 50V, Starting T<sub>J</sub> = 25 °C
3. I<sub>SD</sub> ≤ 20A, di/dt ≤ 200A/μs, V<sub>DD</sub> ≤ BV<sub>DSS</sub>, Starting T<sub>J</sub> = 25 °C
4. Pulse Test: Pulse width ≤ 300μs, Duty Cycle ≤ 2%
5. Essentially Independent of Operating Temperature Typical Characteristics

# Typical Performance Characteristics

Power dissipation

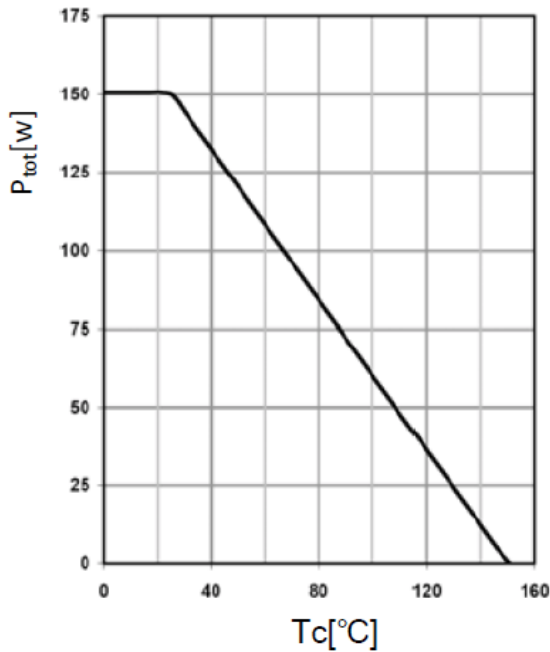

Max. transient thermal impedance

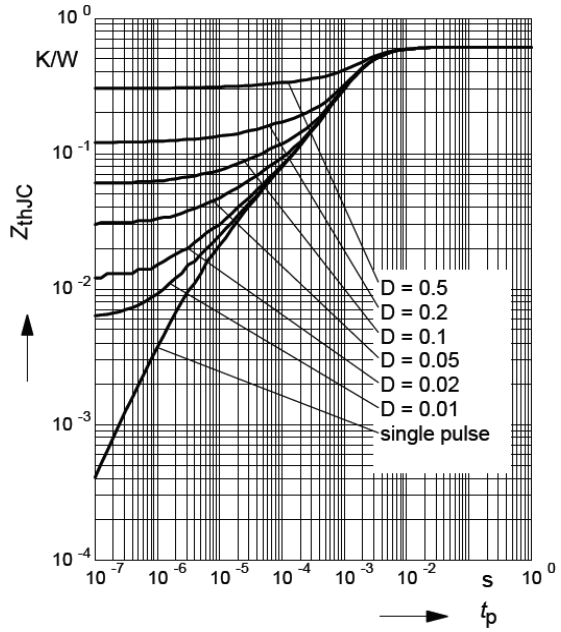

Safe operating area  $T_C=25^\circ C$

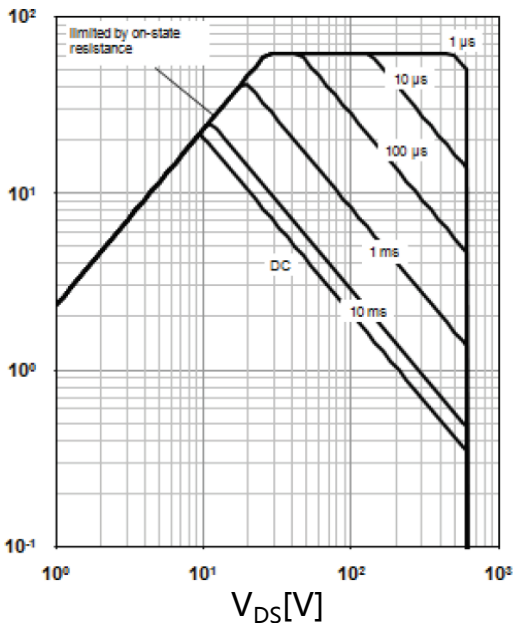

$I_D = f(V_{DS}); T_C = 25^\circ C; V_{GS} > 7V;$   
 $D = 0; \text{parameter } t_p$

Typ. output characteristic

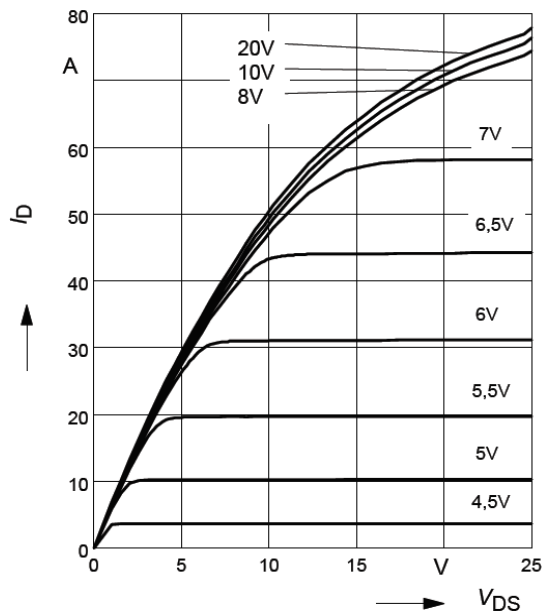

$I_D = f(V_{DS}); T_j = 25^\circ C; \text{parameter } t_p = 10\mu s, V_{GS}$

# Typical Performance Characteristics

Typ. output characteristic

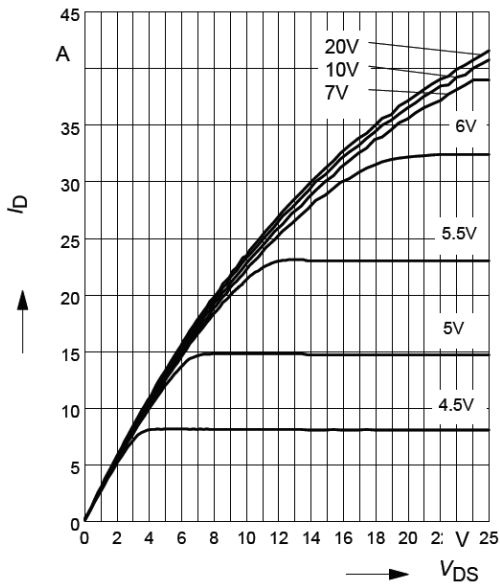

$I_D=f(V_{DS}); T_j=150\text{ }^\circ\text{C};$   
parameter  $t_p=10\mu\text{s}, V_{GS}$

Typ. Drain-Source on resistance

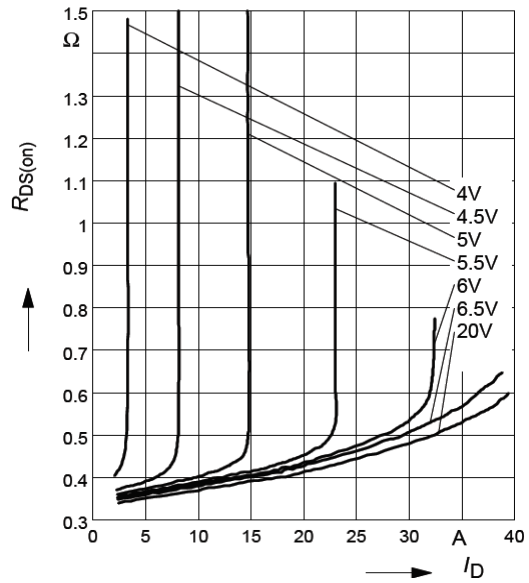

$R_{Dson}=f(I_D); T_j=150\text{ }^\circ\text{C};$  parameter  $V_{GS}$

Typ. Drain-Source on resistance

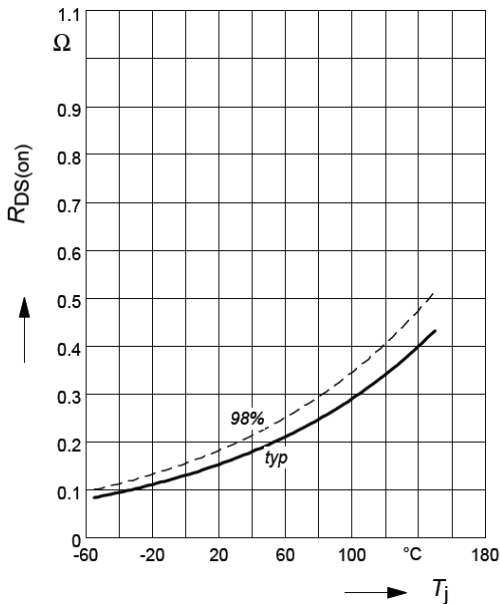

$R_{Dson}=f(T_j); T_j=150\text{ }^\circ\text{C};$  parameter  
 $I_D=13.1\text{A } V_{GS}=10\text{V}$

Typ. Transfer characteristic

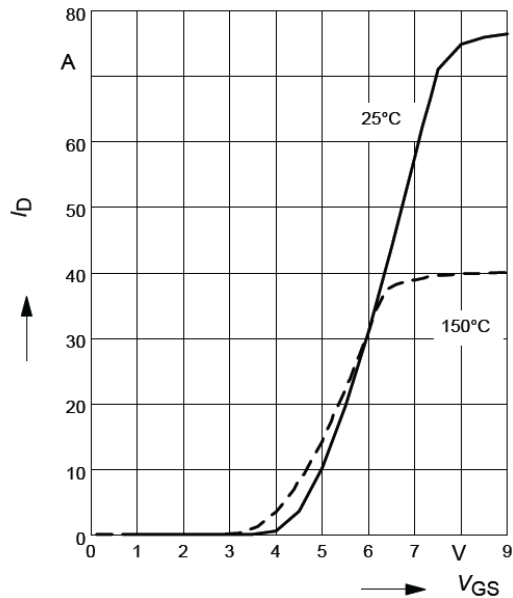

$I_D=f(V_{DS}); V_{DS}>2 \times I_D \times R_{DS(on)max};$   
parameter  $t_p=10\mu\text{s},$

# Typical Performance Characteristics

Forward characteristics of reverse diode

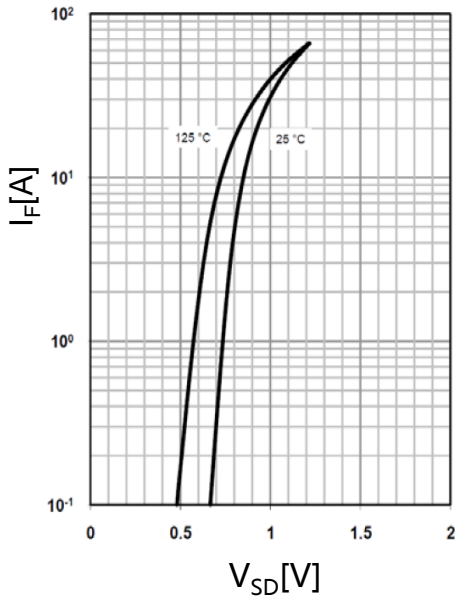

$I_F=f(V_{SD});$  parameter:  $T_j$

Typ. gate charge

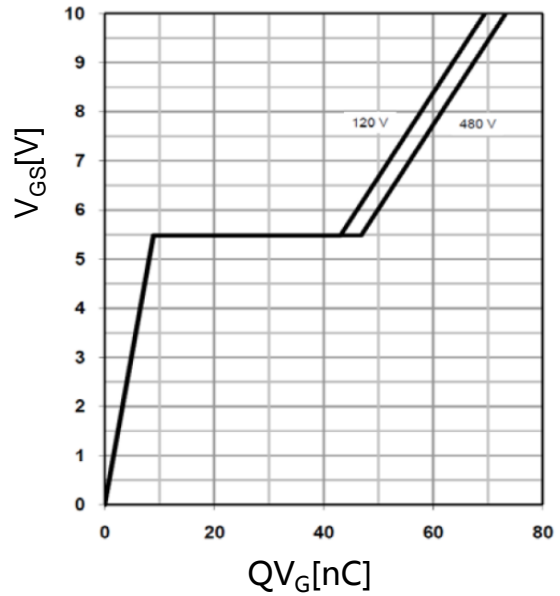

$V_{GS}=f(Q_g), I_D=11$  A pulsed

Avalanche energy

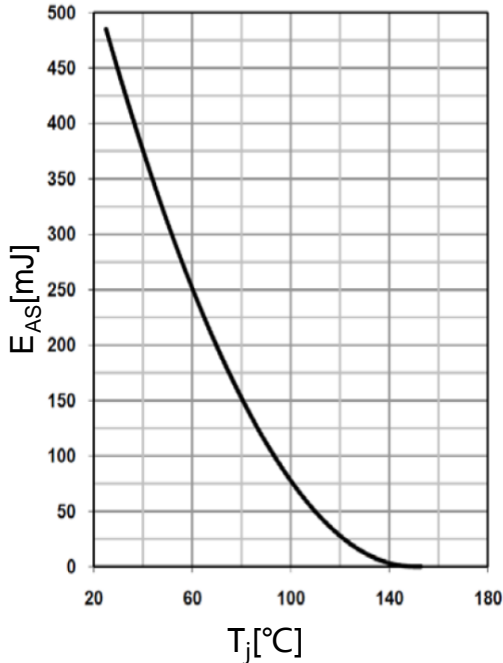

$E_{AS}=f(T_j); I_D=3.5$  A;  $V_{DD}=50$  V

Drain-source breakdown voltage

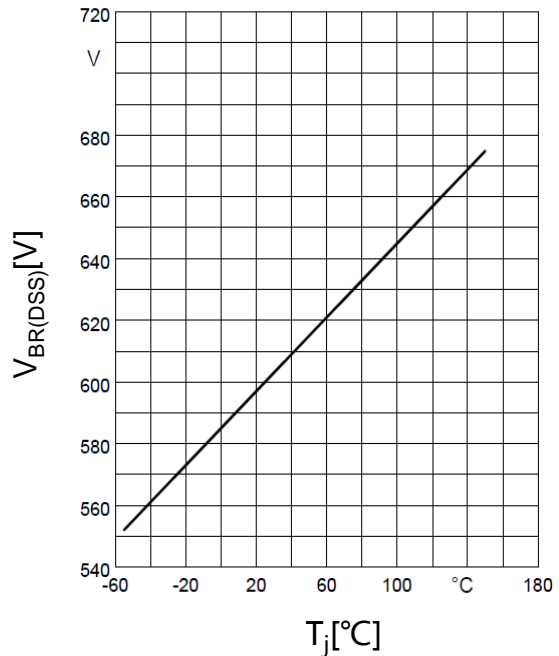

$V_{BR(DSS)}=f(T_j); I_D=1.0$  mA

# Typical Performance Characteristics

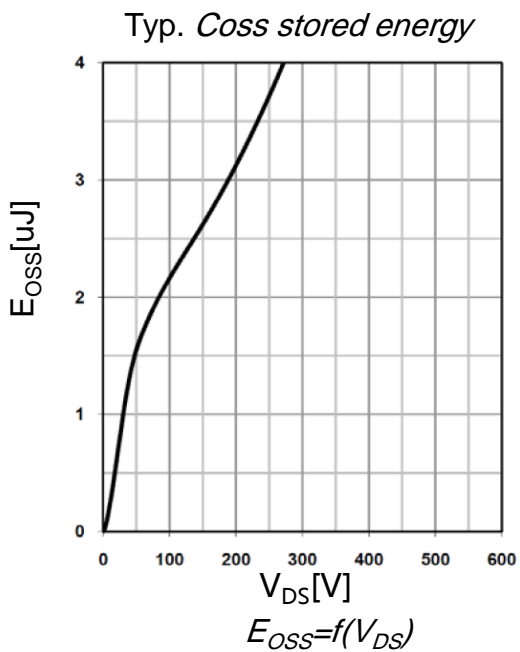
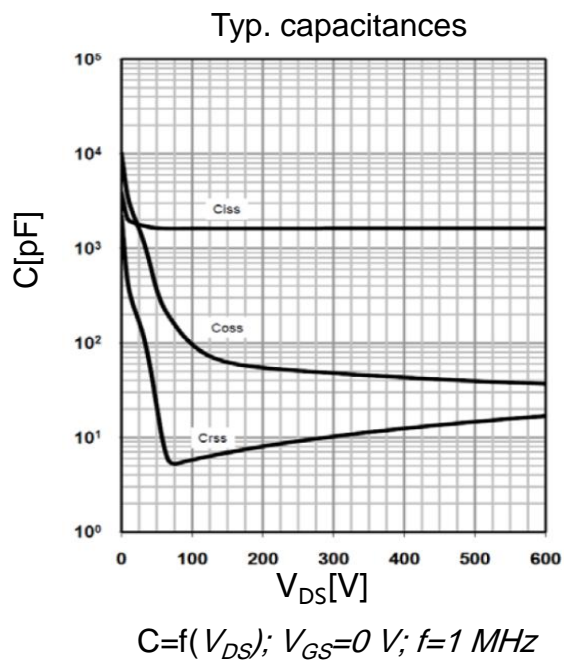

# Test circuits

## Switching times test circuit and waveform for inductive load

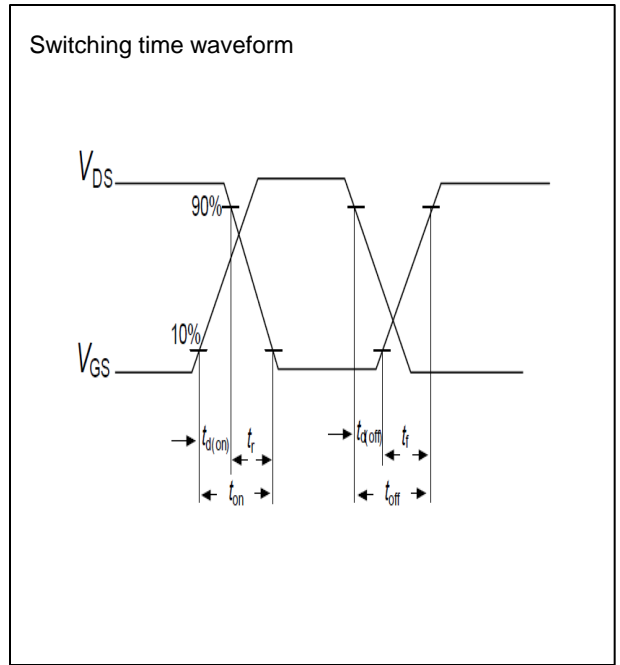
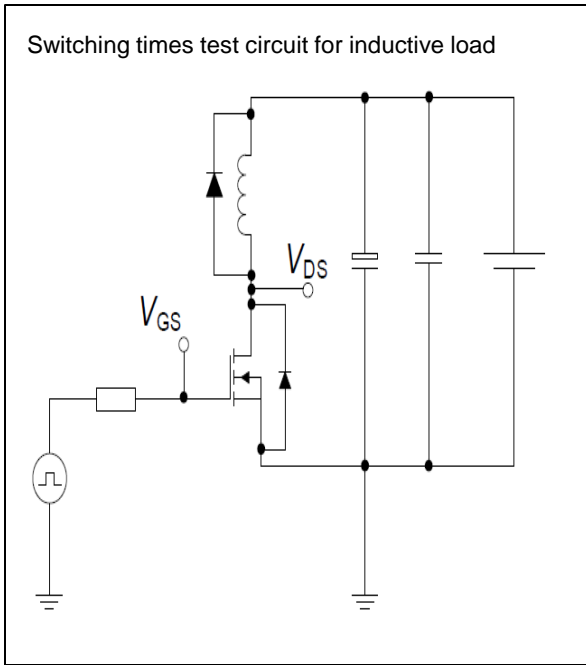

## Unclamped inductive load test circuit and waveform

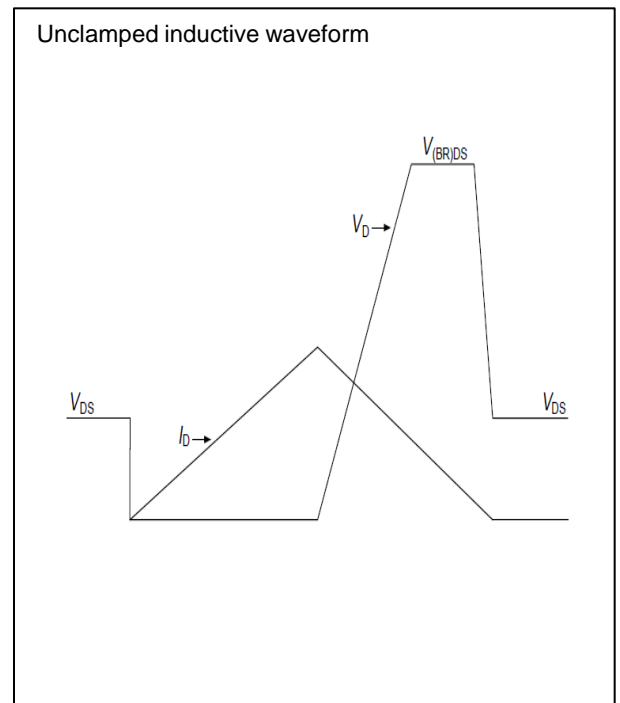
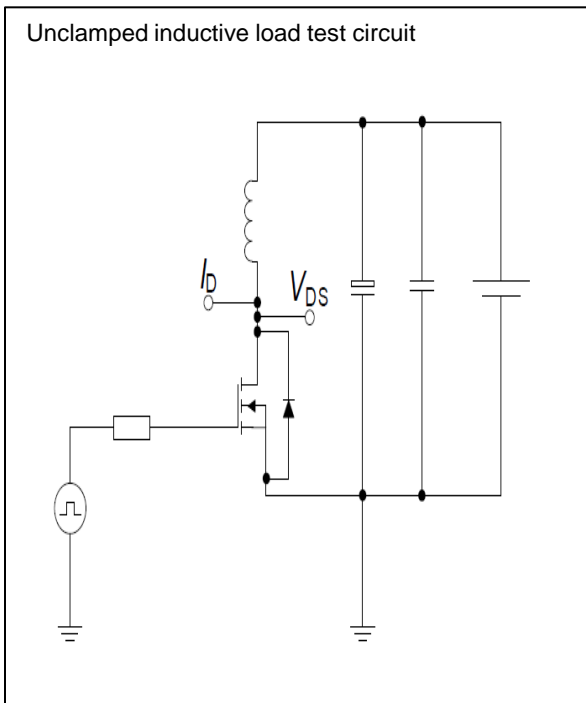

# Test circuits

## Test circuit and waveform for diode characteristics

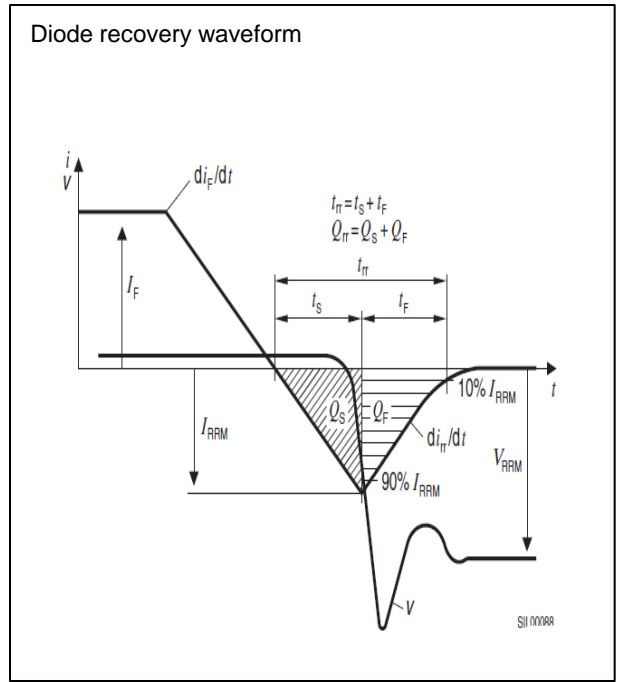
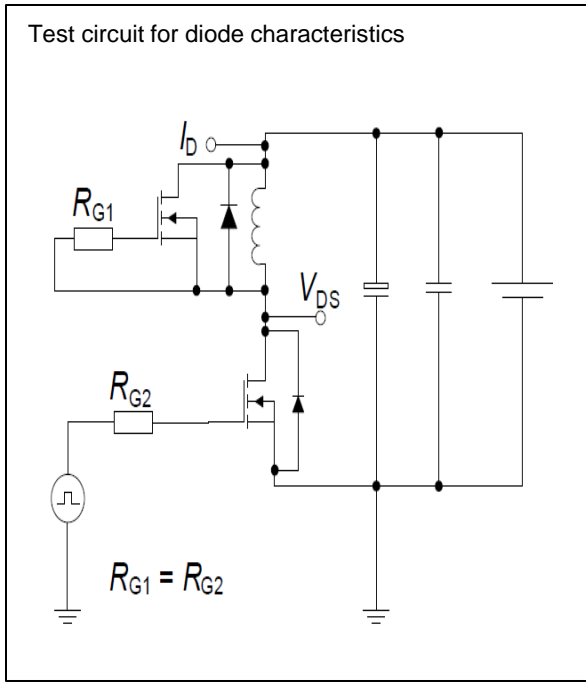



# Package Outline TO-247

TSK60R190S1 600V 20A N-Channel SJ-MOSFET

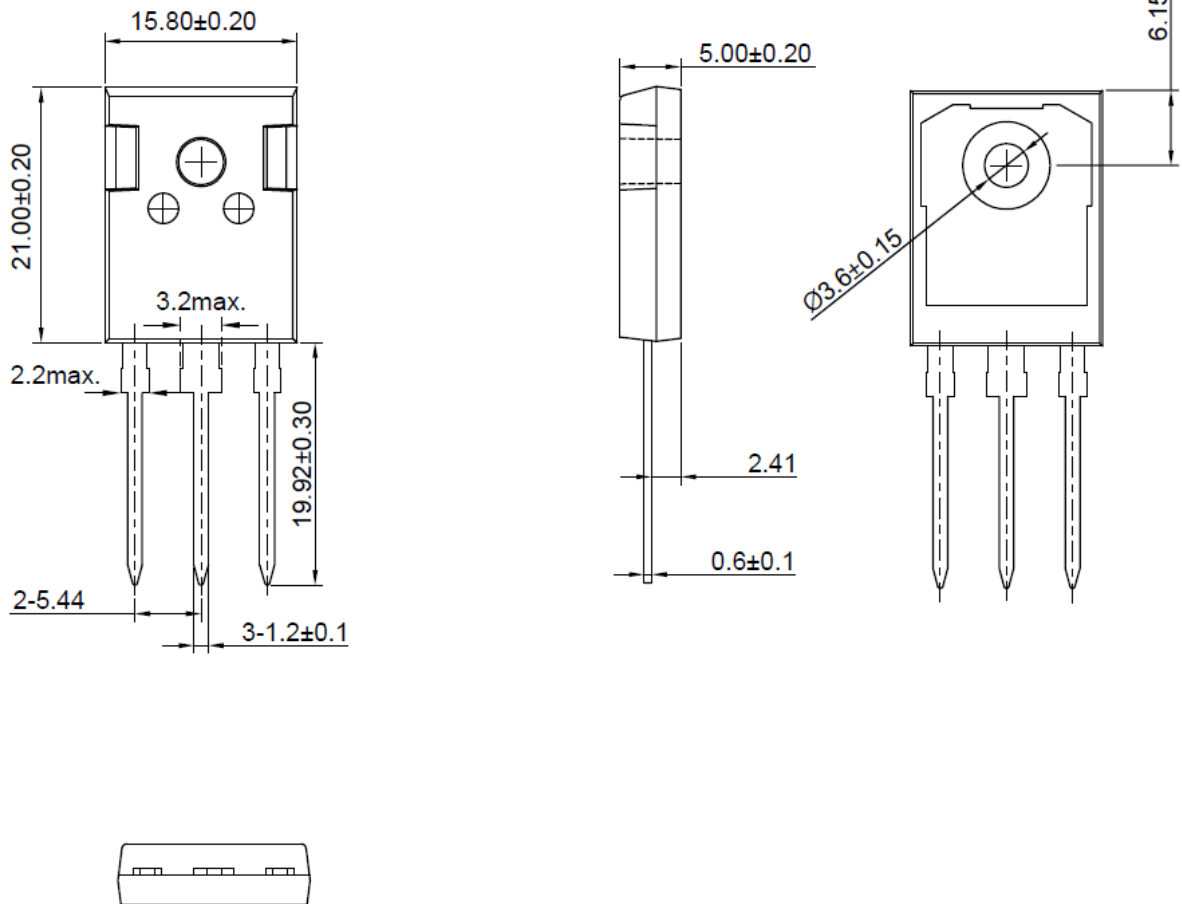

NOTES: 1. 表面粗糙度  $Ra=1.14 \pm 0.20 \mu\text{m}$ .  
 2. 未标注公差  $\pm 0.15$