

TSF65R500S1

650V 9A N-Channel SJ-MOSFET

General Description

Truesemi SJ-FET is new generation of high voltage MOSFET family that is utilizing an advanced charge balance mechanism for outstanding low on-resistance and lower gate charge performance. This advanced technology has been tailored to minimize conduction loss, provide superior switching performance, and withstand extreme dv/dt rate and higher avalanche energy. SJ-FET is suitable for various AC/DC power conversion in switching mode operation for higher efficiency.

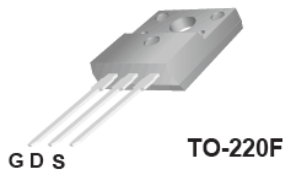

Features

- 700V @T_J = 150 °C
- Typ. R_{DS(on)} = 0.45Ω
- Ultra Low gate charge (typ. Q_g = 35nC)
- 100% avalanche tested



Absolute Maximum Ratings

Symbol	Parameter	Value	Unit
V _{DSS}	Drain-Source Voltage	650	V
I _D	Drain Current -Continuous (TC = 25°C) -Continuous (TC = 100°C)	9* 5.5*	A
I _{DM}	Drain Current – Pulsed (Note 1)	26*	A
V _{GSS}	Gate-Source voltage	±30	V
E _{AS}	Single Pulsed Avalanche Energy (Note 2)	120	mJ
I _{AR}	Avalanche Current (Note 1)	2	A
E _{AR}	Repetitive Avalanche Energy (Note 1)	0.32	mJ
dv/dt	Peak Diode Recovery dv/dt (Note 3)	15	V/ns
P _D	Power Dissipation (TC = 25°C) -Derate above 25°C	35 0.3	W W/°C
T _J , T _{STG}	Operating and Storage Temperature Range	-55 to +150	°C
T _L	Maximum Lead Temperature for Soldering Purpose, 1/8" from Case for 5 Seconds	300	°C

* Drain current limited by maximum junction temperature.

Thermal Characteristics

Symbol	Parameter	Value	Unit
R _{θJC}	Thermal Resistance, Junction-to-Case	4.0	°C/W
R _{θCS}	Thermal Resistance, Case-to-Sink Typ.	--	°C/W
R _{θJA}	Thermal Resistance, Junction-to-Ambient	80	°C/W

Electrical Characteristics TC = 25 °C unless otherwise noted

Symbol	Parameter	Conditions	Min	Typ	Max	Unit
Off Characteristics						
BV _{DSS}	Drain-Source Breakdown Voltage	V _{GS} = 0V, I _D = 250μA, T _J = 25 °C	600	--	--	V
		V _{GS} = 0V, I _D = 250μA, T _J = 150 °C	--	650	--	V
ΔBV _{DSS} / ΔT _J	Breakdown Voltage Temperature Coefficient	I _D = 250μA, Referenced to 25 °C	--	0.6	--	V/°C
I _{DSS}	Zero Gate Voltage Drain Current	V _{DS} = 600V, V _{GS} = 0V -T _C = 150 °C	--	-- 10	1 --	μA μA
I _{GSSF}	Gate-Body Leakage Current, Forward	V _{GS} = 30V, V _{DS} = 0V	--	--	100	nA
I _{GSSR}	Gate-Body Leakage Current, Reverse	V _{GS} = -30V, V _{DS} = 0V	--	--	-100	nA
On Characteristics						
V _{GS(th)}	Gate Threshold Voltage	V _{DS} = V _{GS} , I _D = 250μA	2.5	--	4.5	V
R _{DS(on)}	Static Drain-Source On-Resistance	V _{GS} = 10V, I _D = 4.5A	--	0.45	0.5	Ω
g _{FS}	Forward Trans conductance	V _{DS} = 40V, I _D = 4.5A (Note 4)	--	16	--	S
R _g	Gate resistance	f=1MHz, open drain	--	4.5	--	Ω
Dynamic Characteristics						
C _{iss}	Input Capacitance	V _{DS} = 25V, V _{GS} = 0V, f = 1.0MHz	--	550	--	pF
C _{oss}	Output Capacitance		--	140	--	pF
C _{rss}	Reverse Transfer Capacitance		--	7	--	pF
Switching Characteristics						
t _{d(on)}	Turn-On Delay Time	V _{DD} = 400V, I _D = 4.5A R _G = 20Ω (Note 4, 5)	--	15	--	ns
t _r	Turn-On Rise Time		--	10	--	ns
t _{d(off)}	Turn-Off Delay Time		--	110	--	ns
t _f	Turn-Off Fall Time		--	9	--	ns
Q _g	Total Gate Charge	V _{DS} = 480V, I _D = 4.5A V _{GS} = 10V (Note 4, 5)	--	35	--	nC
Q _{gs}	Gate-Source Charge		--	3.8	--	nC
Q _{gd}	Gate-Drain Charge		--	4	--	nC
Drain-Source Diode Characteristics and Maximum Ratings						
I _S	Maximum Continuous Drain-Source Diode Forward Current		--	--	9	A
I _{SM}	Maximum Pulsed Drain-Source Diode Forward Current		--	--	40	A
V _{SD}	Drain-Source Diode Forward Voltage	V _{GS} = 0V, I _F = 4.5A	--	0.9	1.5	V
t _{rr}	Reverse Recovery Time	V _{GS} = 0V, I _F = 4.5A di _F /dt = 100A/μs (Note 4)	--	240	--	ns
Q _{rr}	Reverse Recovery Charge		--	3.1	--	μC

NOTES:

1. Repetitive Rating: Pulse width limited by maximum junction temperature
2. L=60mH, I_{AS}=2A, V_{DD}=50V, Starting T_J=25 °C
3. I_{SD}≤9A, di/dt ≤ 200A/μs, V_{DD} ≤ BV_{DSS}, Starting T_J = 25 °C
4. Pulse Test: Pulse width ≤ 300μs, Duty Cycle ≤ 2%
5. Essentially Independent of Operating Temperature Typical Characteristics

Typical Performance Characteristics

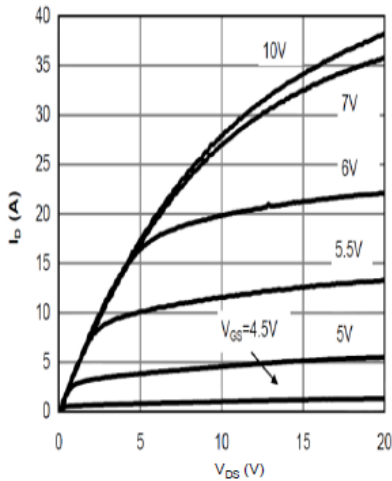

Figure 1: On-Region Characteristics@25°C

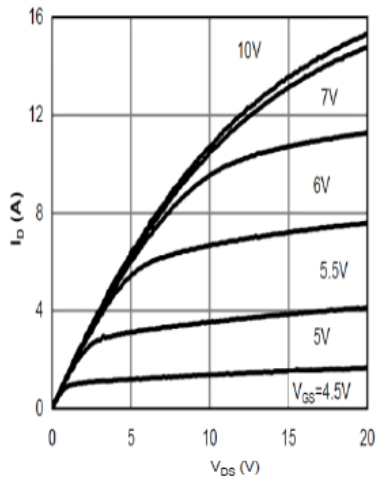

Figure 1: On-Region Characteristics@125°C

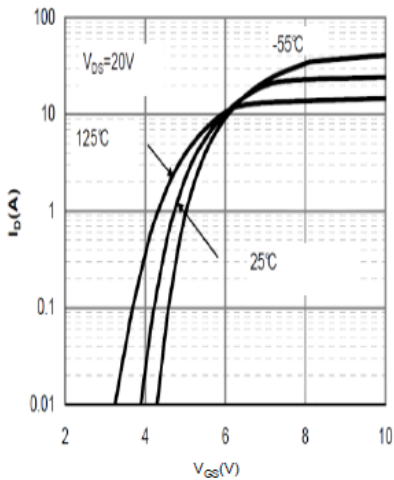

Figure 3: Transfer Characteristics

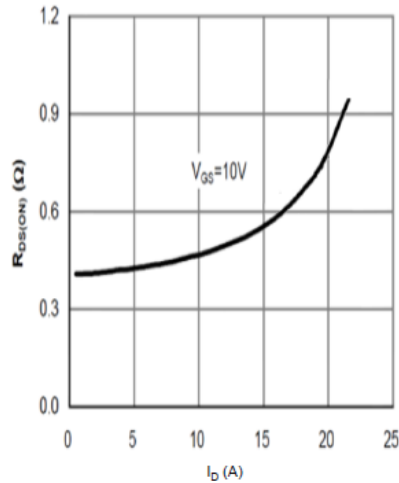

Figure 4: On-Resistance vs. Drain Current and Gate Voltage

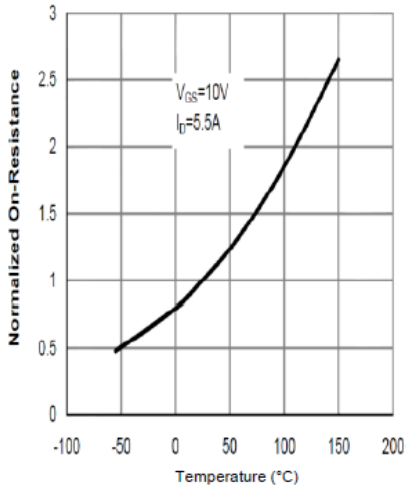

Figure 5: On-Resistance vs. Junction Temperature

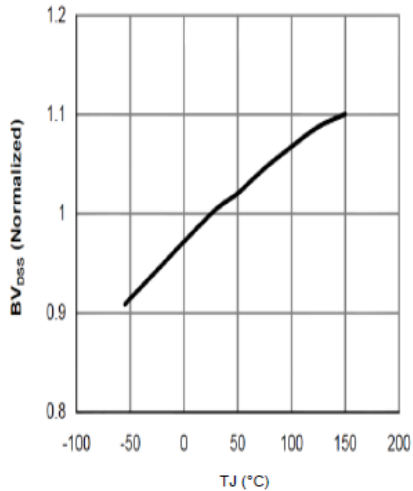

Figure 6: Break Down vs. Junction Temperature

Typical Performance Characteristics

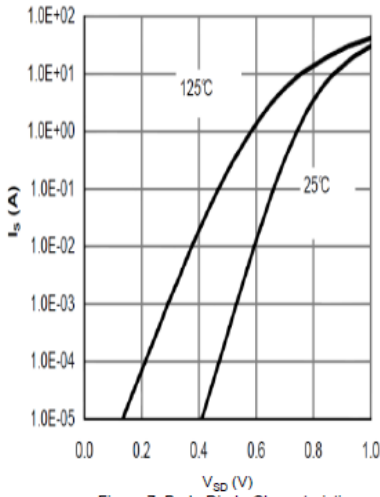

Figure 7: Body-Diode Characteristics

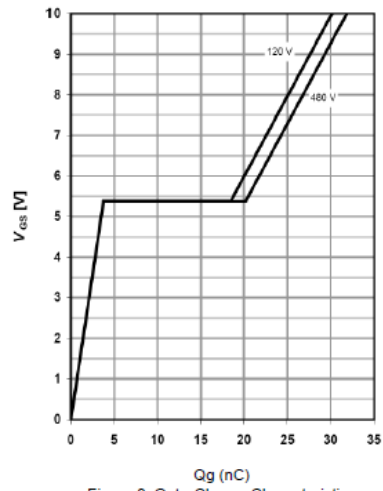

Figure 8: Gate-Charge Characteristics

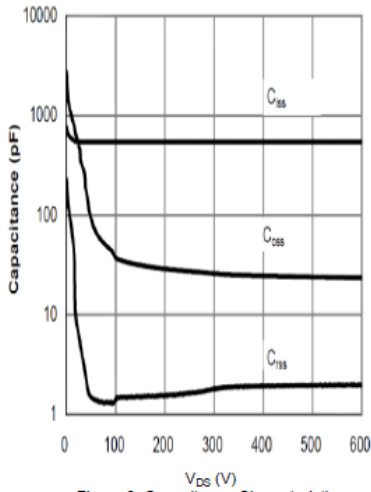

Figure 9: Capacitance Characteristics

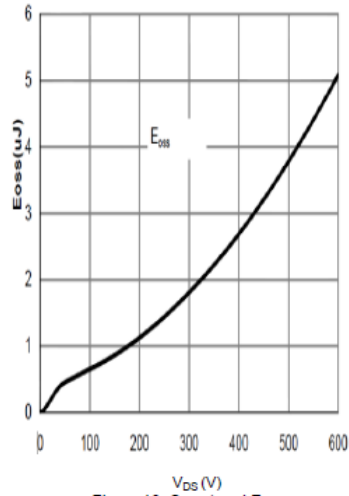

Figure 10: C_{oss} stored Energy

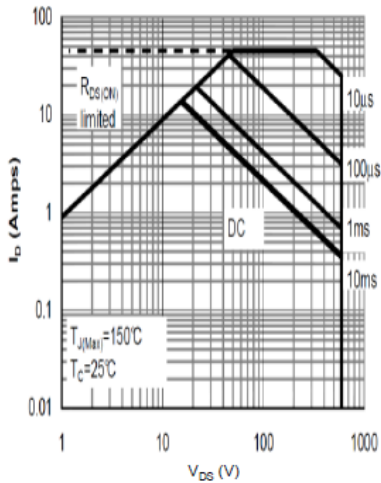

Figure 11: Maximum Forward Biased Safe Operating Area

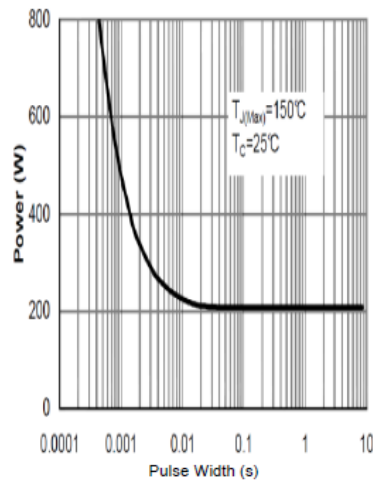

Figure 12: Single Pulse Power Rating Junction-to-Case

Typical Performance Characteristics

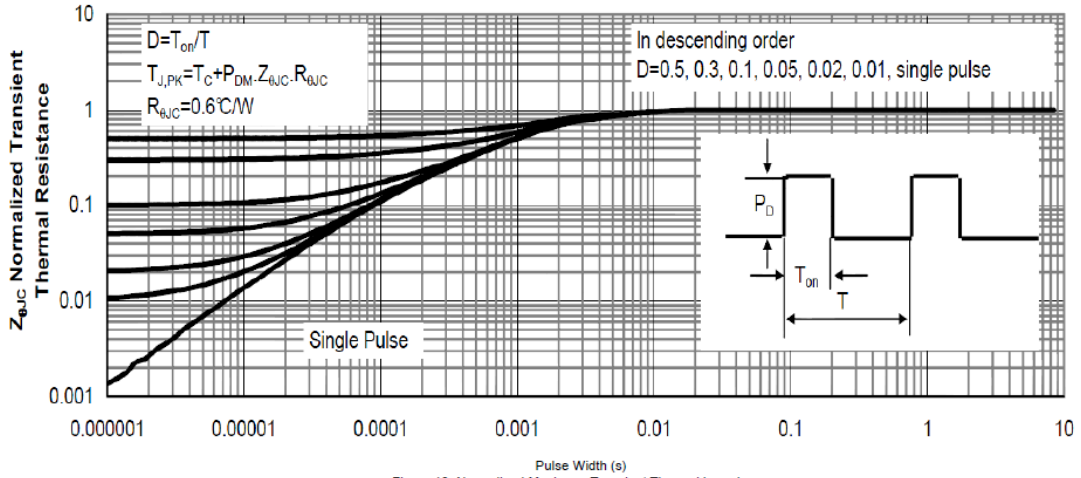

Figure 13: Normalized Maximum Transient Thermal Impedance

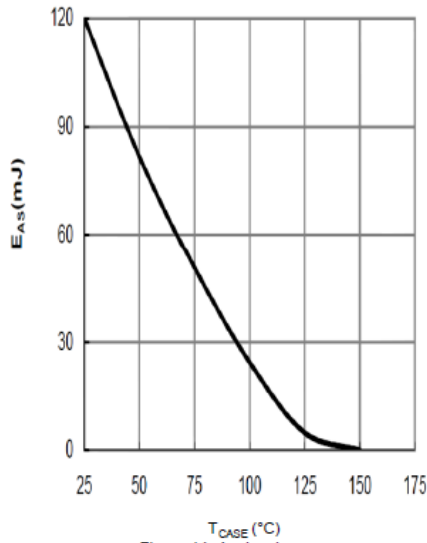

Figure 14: Avalanche energy

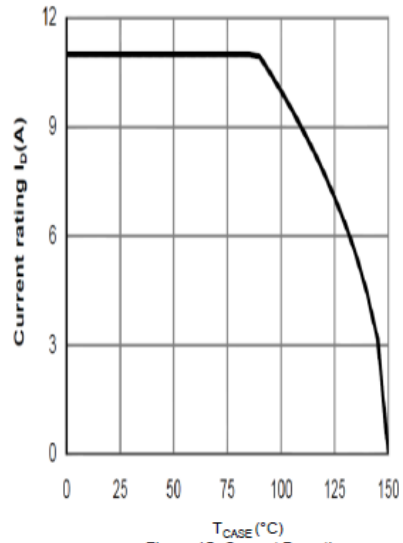

Figure 15: Current De-rating

Typical Performance Characteristics

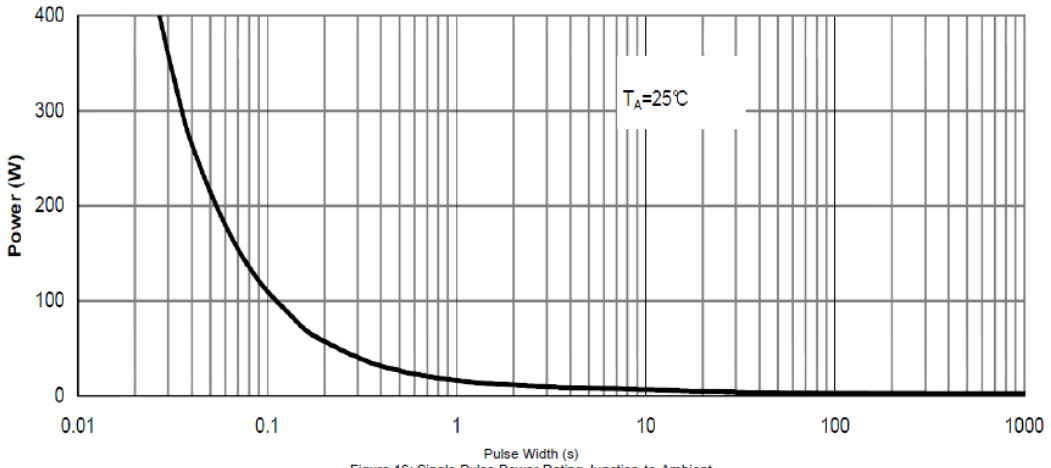

Figure 16: Single Pulse Power Rating Junction-to-Ambient

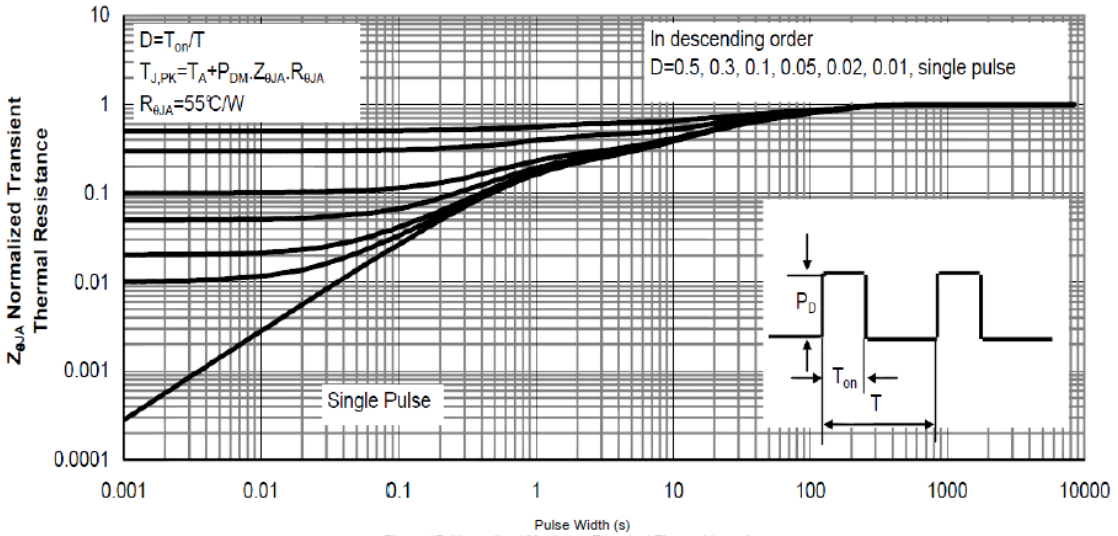
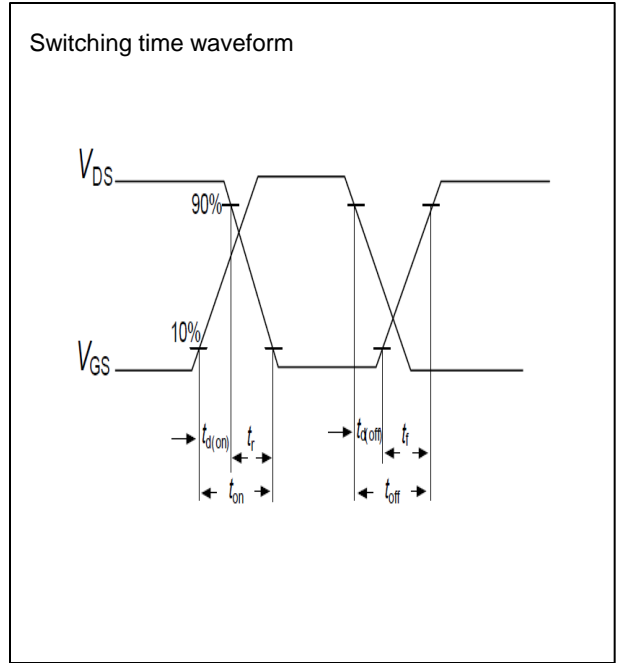
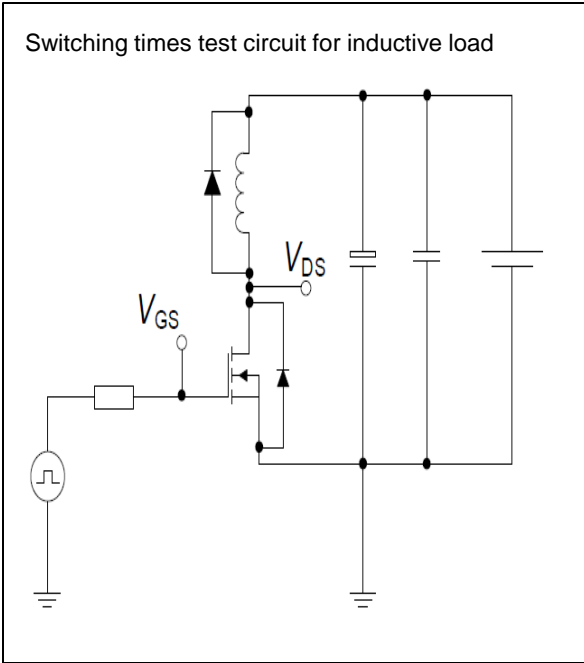

Figure 17: Normalized Maximum Transient Thermal Impedance

Test circuits

Switching times test circuit and waveform for inductive load



Unclamped inductive load test circuit and waveform

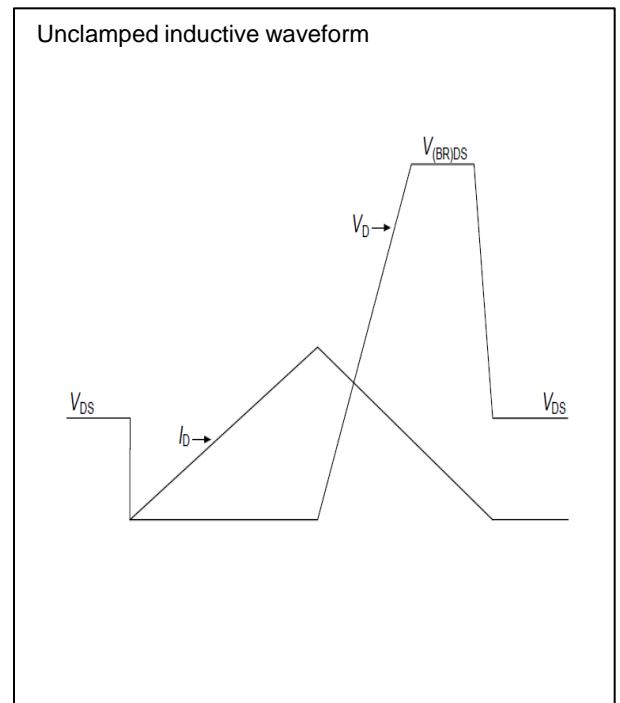
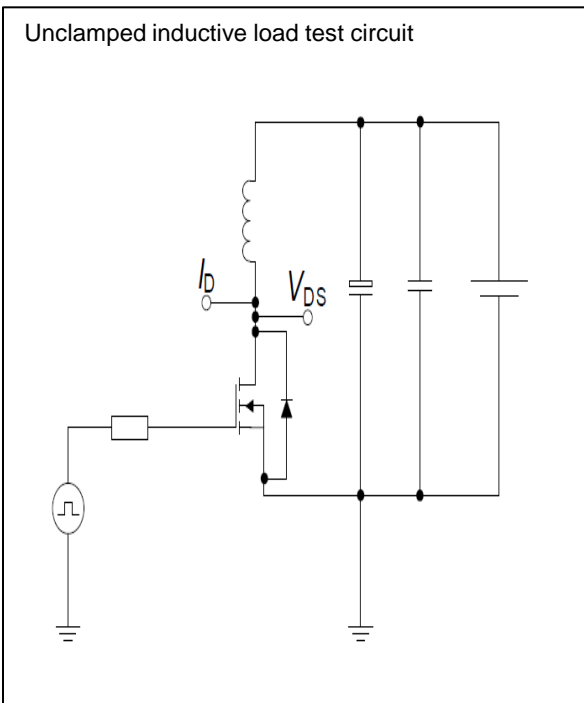

Test circuits

Test circuit and waveform for diode characteristics

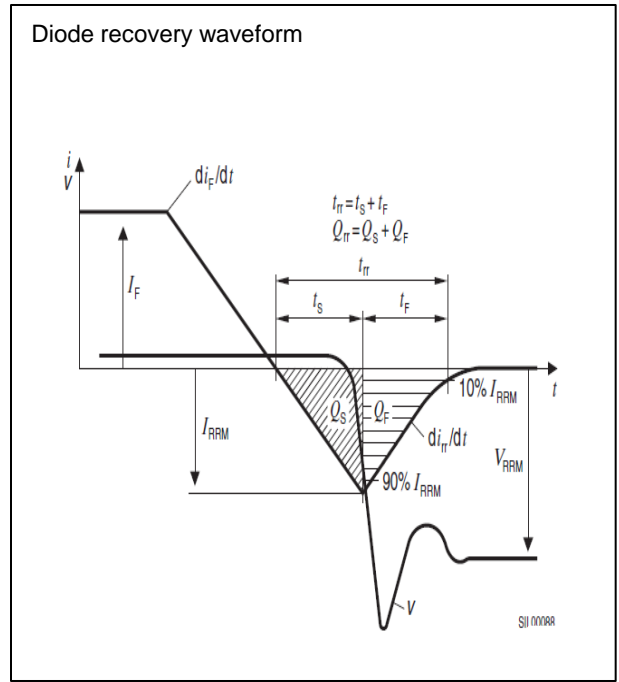
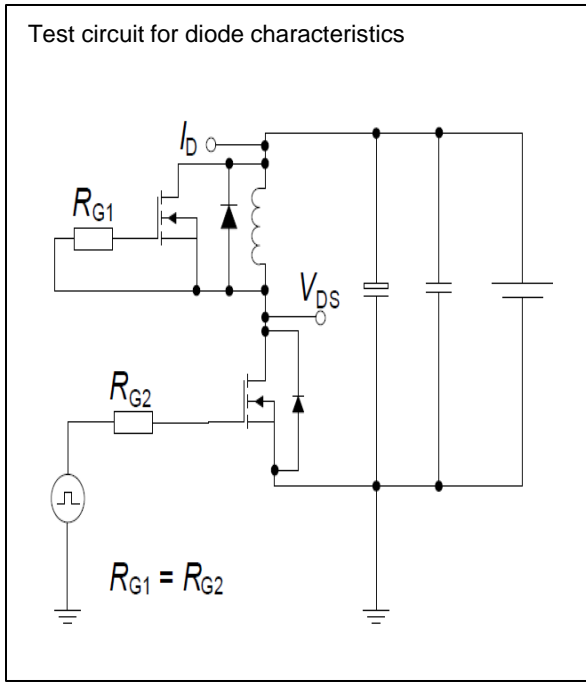

Package Outline TO-220F

TSF65R500S1 650V 9A N-Channel SJ-MOSFET

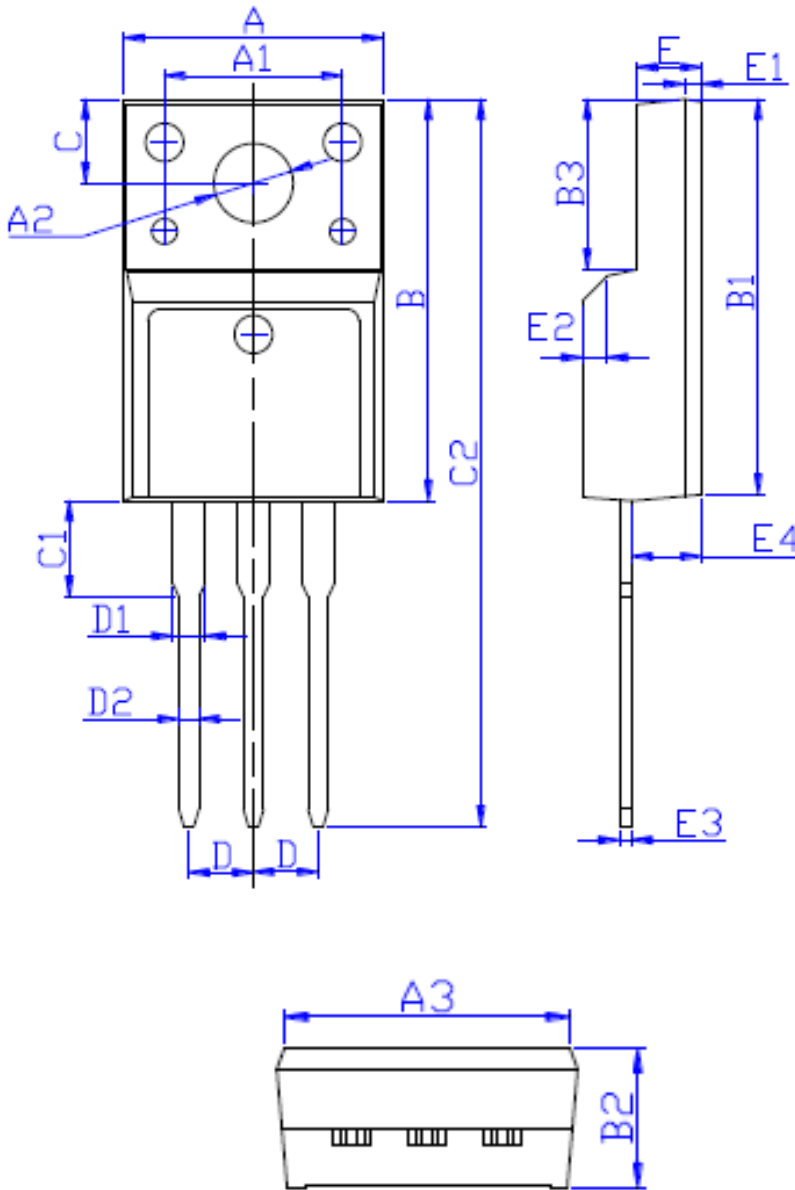

DIM	MILLIMETERS
A	10.16 ± 0.30
A1	7.00 ± 0.20
A2	3.12 ± 0.20
A3	9.70 ± 0.30
B	15.90 ± 0.50
B1	15.60 ± 0.50
B2	4.70 ± 0.30
B3	6.70 ± 0.30
C	3.30 ± 0.25
C1	3.25 ± 0.30
C2	28.70 ± 0.50
D	Typical 2.54
D1	1.47 (MAX)
D2	0.80 ± 0.20
E	2.55 ± 0.25
E1	0.70 ± 0.25
E2	1.0 × 45°
E3	0.50 ± 0.20
E4	2.75 ± 0.30